

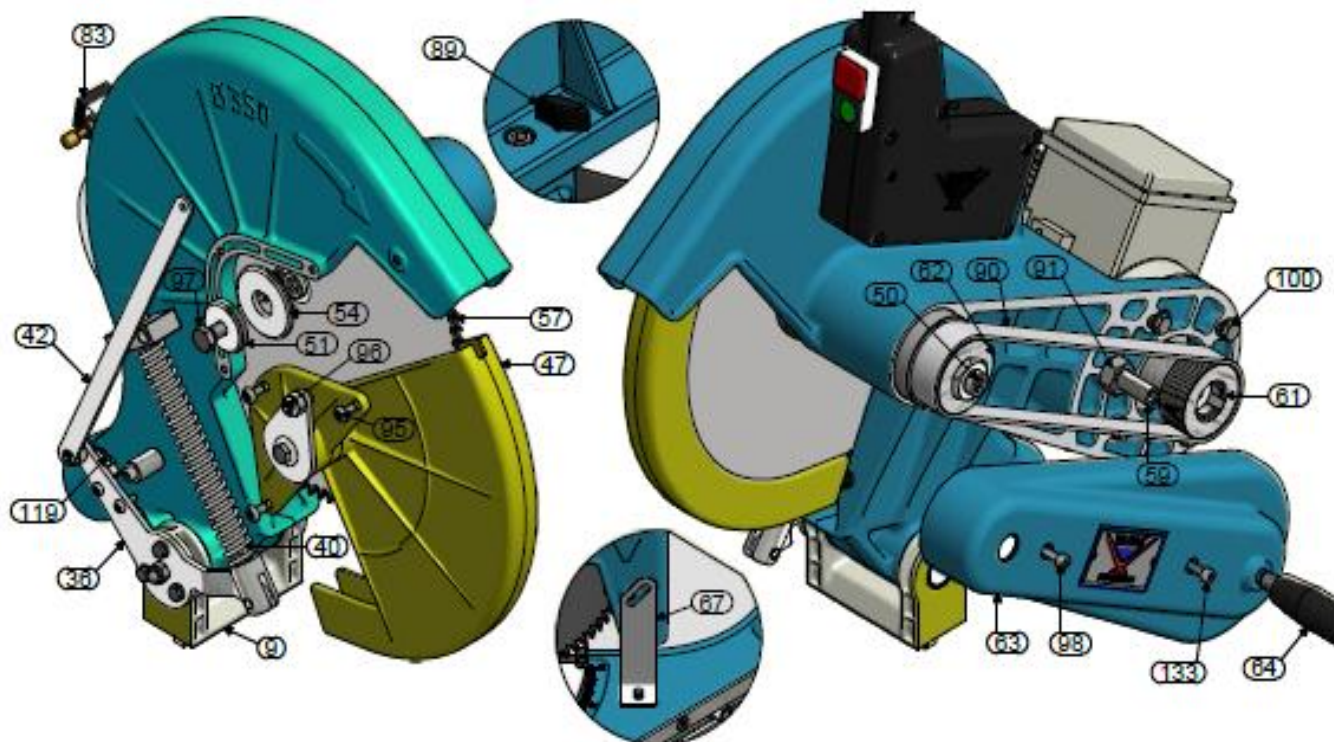

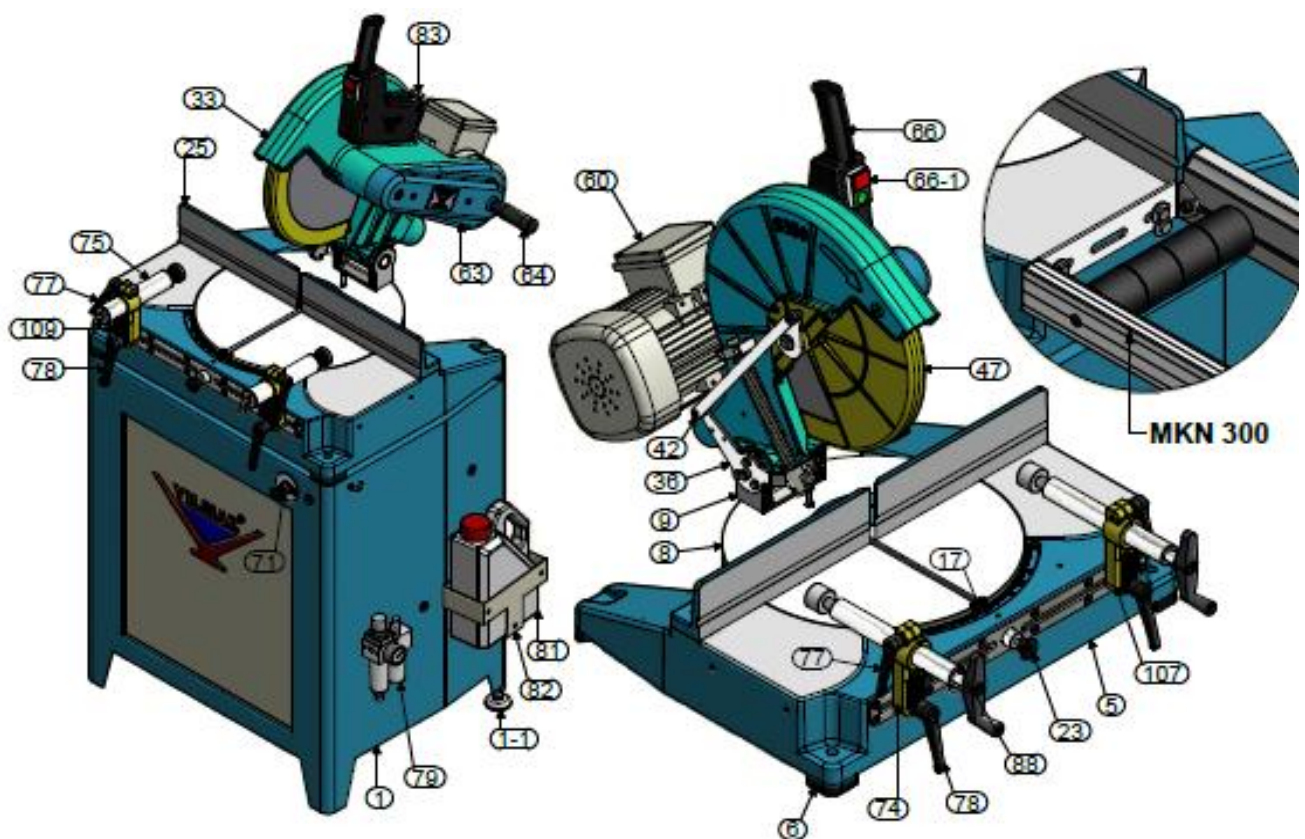

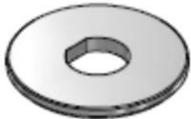





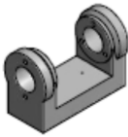
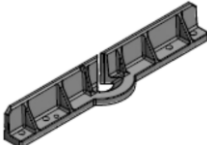

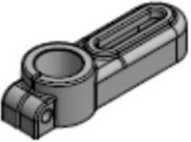
**Запасные части для одноголовых пил  
«YILMAZ» модель «KD-400M и KD-400P»**



№	Артикул	кол-во	№	Артикул	кол-во
1	1SA010000-0060	1	57	1SK010000-0003 (KD 350)	1
5	2TU012510-0372	1	57	1SK010000-0004 (KD 400)	1
6	1PL030000-0017	2	59	2TU011110-1018	1
8	2TU011610-0009	1	60	1EL070001-0002 (230 V)	1
9	2TU012510-0128	1	60	1EL070001-0001 (400 V)	1
17	2TU011441-0043	1	61	2TU012110-0029	1
23	3UA03030-0003	1	62	2TU012110-0030	1
25	2TU012510-0362	1	63	2TU012510-0366 (KD 350)	1
33	2TU012510-0363 (KD 350)	1	63	2TU012510-0371 (KD 400)	1
33	2TU012510-0367 (KD 400)	1	64	1PL010000-0076	1
36	2TU011441-0098 (KD 350)	1	66	1PL010000-0042	1
36	2TU011441-0099 (KD 400)	1	66-1	1EL010000-0080	1
40	1YY011000-0023 (KD 350)	1	67	2TU011441-0305	1
40	1YY011000-0025 (KD 400)	1	71	1PN010000-0087	1
42	2TU011210-0073 (KD 350)	1	74	2TU012610-0010	1
42	2TU011210-0100 (KD 400)	1	75	3UA060030-0013	2
47	2TU012510-0364 (KD 350)	1	77	3UA040030-0007	2
47	2TU012510-0369 (KD 400)	1	78	3UA040030-0002	2
50	2TU011110-0135	1	79	3UA110030-0020	1
51	2TU011110-0857	1	83	1PN010000-0012	1
54	2TU011441-0016	1	86	4UN300030-0001	1
87	2TU012610-0009	2			
88	3UA090030-0008	2			
89	2TU011110-0145	1			
90	1SR070000-0007 (KD 350)	1			
90	1SR070000-0006 (KD 400)	1			
91	1SC071000-0005	1			
95	1SC041000-0014	3			
96	1SC131000-0006	2			
97	1SC011000-0002	1			
98	1SC0210000-0050	5			
100	1SC011000-0036	4			
107	2TU012610-0053	1			
107	2TU012610-0010	1			
119	1PN010000-0157	1			

№	Рисунок	Артикул	Наименование детали
54		2TU011441-0016	ФЛАНЕЦ НАРУЖ.
		2TU011710-0006	ФЛАНЕЦ

9		3UA320030-0002	ВИЛКА
25		2TU012510-0362	ОПОРА ПРОФИЛЯ
47		3UA410030-0014	КОЖУХ ЗАЩИТНЫЙ
74		2TU012610-0009 / 0053 (KD 350-400 M/D) 2TU012610-0010 / 0054 (KD 350-400 P/PS)	КРОНШТЕЙН ПРИЖИМА
75		3UA060030-0013 (KD 350-400 P/PS)	ПРИЖИМ ПНЕВМАТИЧЕСКИЙ
88		3UA090030-0008 (KD 350-400 M/D)	ПРИЖИМ МЕХАНИЧЕСКИЙ
77		3UA040030-0007	РУЧКА-ФИКСАТОР M8x32
78		3UA040030-0002	РУЧКА-ФИКСАТОР M12*60
43		1SK010000-0003 (KD 350) 1SK010000-0004 (KD 400)	ПИЛЬНЫЙ ДИСК 400 ММ.
83		1PN010000-0012 (KD 350-400 PS)	КЛАПАН РАСПЫЛЕНИЯ
		1SR010000-0005	ПОДШИПНИК 6204
90		1SR070000-0007 (KD 350) 1SR070000-0006 (KD 400)	РЕМЕНЬ ПРИВОДНОЙ

75-1		1PL010000-0033	НАСАДКА ПРИЖИМА
66		1PL010000-0042	РУЧКА
66-1		1EL090000-0017	КНОПКА
60		1EL070001-0002 (230V-1P 50 Hz) 1EL070001-0017 (240V-1P 50 Hz) 1EL070001-0019 (220V-1P 60 Hz) 1EL070001-0001 (400V-415V 3P 50 Hz) (440V-3P 60 Hz)	МОТОР
79		3UA110030-0020	БЛОК ПОДГОТОВКИ ВОЗДУХА
119		1PN0140000-0157	AZ 431 MP РАСПРЕДЕЛИТЕЛЬ