

Запасные части для двухголовочных пил с фронтальной подачей дисков «YILMAZ» модель «DC 421»

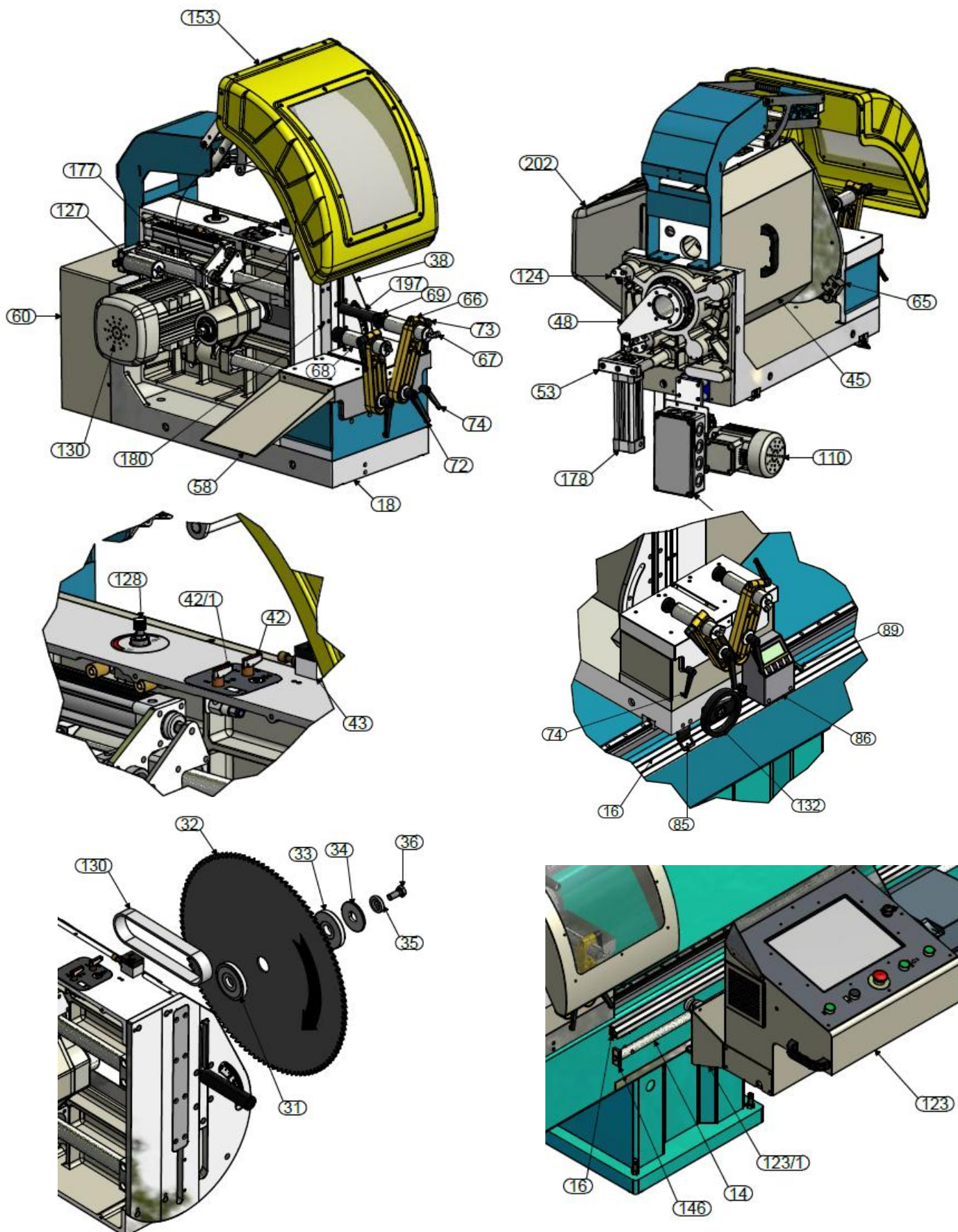









№	АРТИКУЛ	КОЛ-ВО	№	АРТИКУЛ	КОЛ-ВО
6	1SR080000-0034	4	60	1SA030000-0080	1
14	2TU014010-0182:	1	65	2TU011210-0723	2
16	2TU012310-0071	1	72	3UA060030-0004	4
29	1PN020000-0072	2	74	3UA040030-0021	2
31	2TU011110-0422	2	85	2TU011441-0641	1
33	2TU011110-0423	2	86	2TU012510-0388	1
34	2TU011441-0016	2	110	1EL070001-0011 *	1
35	2TU011110-0203	2	123	1SA020000-0053 **	1
36	1SC021000-0003	2	123/1	2TU011441-0628 *	1
38	2TU011410-0082	1	124	2TU011110-1105	4
44	1SA030000-0082	1	127	3UA050030-0020	2
45	2TU011441-0643	1	130	1EL070001-0001	2
48	2TU011441-0637	2	132	3UA690030-0125	1
53	2TU011210-0303	2	134	1SA030000-0087	2
54	1PN020000-0173	2	143	3UA690030-0107	2
58	1SA050000-0228	1	146	2TU011210-0087	2

*DC 421 P

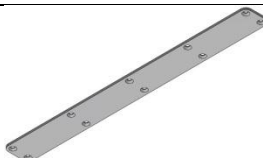
** DC 421 PB

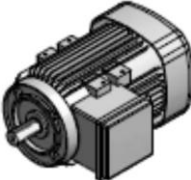
№	РИСУНОК	АРТИКУЛ	НАИМЕНОВАНИЕ ДЕТАЛИ
66		2TU012610-0044	КРОНШТЕЙН ПРИЖИМА
68		3UA060030-0004	ПНЕВМОЦИЛИНДР
67		1PN140000-0005	1/8-6 ФИТИНГ
73		3UA040030-0007	РУЧКА ФИКСАТОР M8x32
72		3UA040030-0001	РУЧКА ФИКСАТОР M12*60

74		3UA040030-0021	РУЧКА ФИКСАТОР М12*35
32		1SK010000-0046	ДИСК ПИЛЬНЫЙ Ø 420
130		1SR070000-0005	ПРИВОДНОЙ РЕМЕНЬ
43		1PN010000-0012	КЛАПАН РАСПЫЛЕНИЯ
180		2TU011441-0014	SAW CHUTE PLATE
69		1PL010000-0033	НАСАДКА НА ПРИЖИМ
130		1EL070001-0002 400V-415V (3P 50 Hz)	ДВИГАТЕЛЬ
132		2TU010010-0011	МАХОВИК
		1EL200000-0124	КОНЦЕВИК